

Beschläge
& mehr

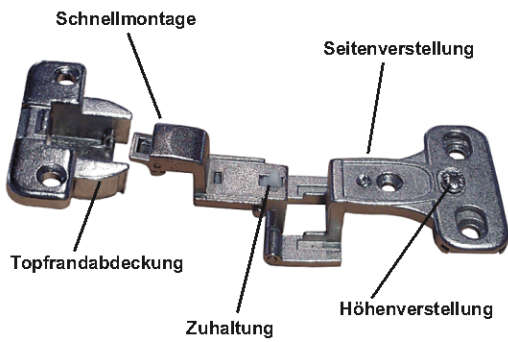

Scharniere



Schnellmontage-Scharnier mit Clip-technik, mit sichtbarer Rolle, Fuge 4mm

Topdurchmesser 35mm, zum Anschrauben

Bohrbild : 45mm

Material: Zamak vernickelt

Oberfläche: Weiss

50

	Art. No.
a. Aufliegend	52.1564
b. D = 16mm	52.1563

	Art. No.
Mittelwand	52.1562
c. D = 9,5mm	52.1562

	Art. No.
d. Einliegend	52.1561

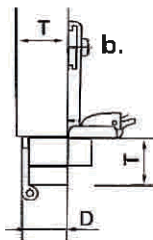
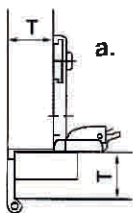

T = Türstärke = 14-19mm
D = Türauflage

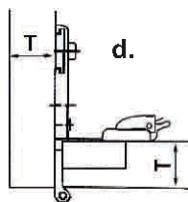
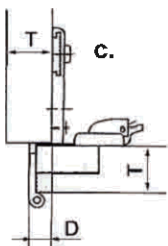

Sichtbare Rolle

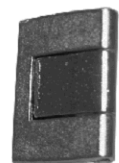

Mittelwand

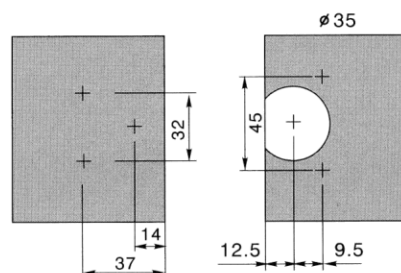
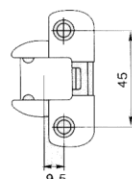
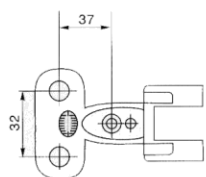
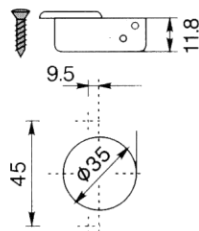

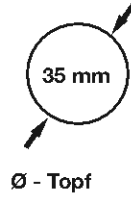
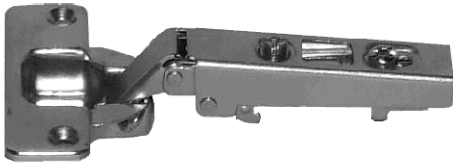

Schnellmontage-Scharnier mit Clip-technik, Eckanschlag für aufliegende Türen

Öffnungswinkel: 110°

Topfdurchmesser 35mm, zum Anschrauben

Bohrbild: 52mm

Material: Stahl vernickelt

200

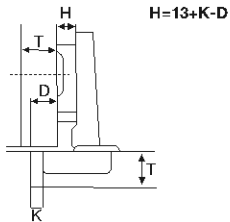

B	K	3	4	5	6	7
H						
0		16	17	18	19	20
2		14	15	16	17	18
4		12	13	14	15	16

Gelenkarm

Art. No.

Gerade

52.1565

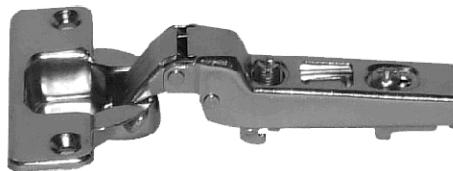

Schnellmontage-Scharnier mit Clip-technik, Mittel- / Zwillingsanschlag für aufliegende Türen

Öffnungswinkel: 110°

Topfdurchmesser 35mm, zum Anschrauben

Bohrbild: 52mm

Material: Stahl vernickelt

200

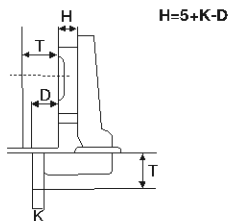

B	K	3	4	5	6	7
H						
0		8	9	10	11	12
2		6	7	8	9	10
4		4	5	6	7	8

Gelenkarm

Art. No.

Gekröpft 8mm

52.1566

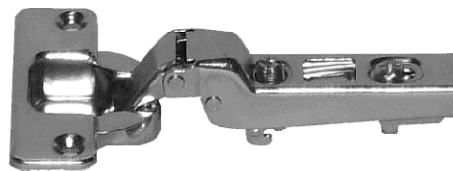

Schnellmontage-Scharnier mit Clip-technik, Eckanschlag für einliegende Türen

Öffnungswinkel: 110°

Topfdurchmesser 35mm, zum Anschrauben

Bohrbild: 52mm

Material: Stahl vernickelt

200

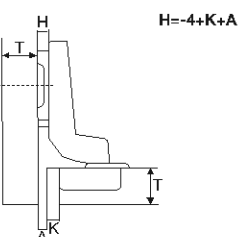

B	K	3	4	5	6	7
H						
0		-1	-2	-3	-4	-5
2		1	0	-1	-2	-3
4		3	2	1	0	-1

Gelenkarm

Art. No.

Gekröpft 17mm

52.1567



Glastürscharnier mit Cliptechnik, aufliegende Montage

Öffnungswinkel: 95°

Topfdurchmesser 26mm, zum Anschrauben

Glastürstärke: 4 - 6mm

Material: Stahl vernickelt

200

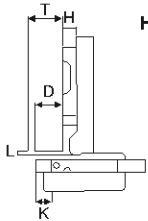

B	K	3	4	5	6
H					
0		18	19	20	21
2		16	17	18	19
4		14	15	16	17

Gelenkarm

Art. No.

Gerade

52.1569

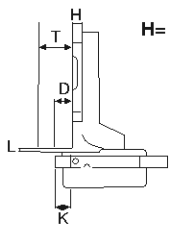
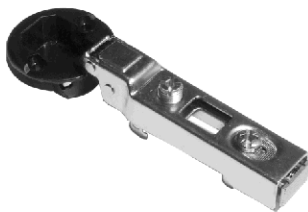

B	K	3	4	5	6
H					
0		8	9	10	11
2		6	7	8	9
4		4	5	6	7

Glastürscharnier mit Cliptechnik, für Mittelwand

Öffnungswinkel: 95°

Topfdurchmesser 26mm, zum Anschrauben

Glastürstärke 4 - 6mm

Material: Stahl vernickelt

200

Gelenkarm

Art. No.

Gekröpft 8mm

52.1570

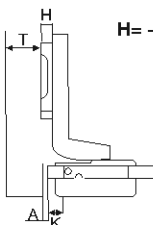
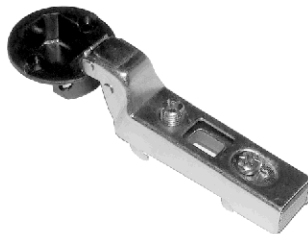

B	K	3	4	5	6
H					
0		0	-1	-2	-3
2		2	1	0	-1
4		4	3	2	1

Glastürscharnier mit Cliptechnik, einliegende Montage

Öffnungswinkel: 95°

Topfdurchmesser 26mm, zum Anschrauben

Glastürstärke 4 - 6mm

Material: Stahl vernickelt

200

Gelenkarm

Art. No.

Gekröpft 17mm

52.1571

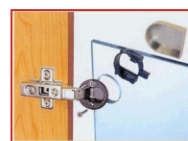
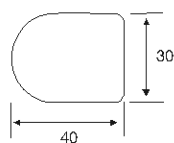
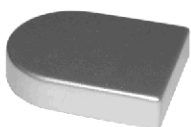

Abdeckplatte, eckig, für Scharniere

200

Material:

Art. No.

Kunststoff vernickelt

52.1568

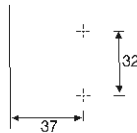

Montageplatte zum Anschrauben

Lochabstand: 32mm

Höhenverstellbar mittels Langloch:
+/-2mm

Material: Stahl vernickelt

200

H=	Art. No.
0mm	52.1577
2mm	52.1578
4mm	52.1579

Bestimmung von Maß H -Eine Seite vorher

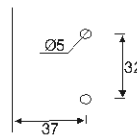
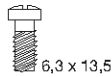
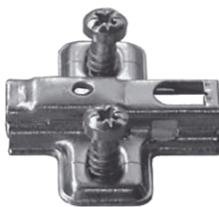

Montageplatte mit vormontierten Euro-schrauben

Lochabstand: 32mm

Höhenverstellbar mittels Langloch:
+/-2mm

Material: Stahl vernickelt

200

H=	Art. No.
0mm	52.1580
2mm	52.1581
4mm	52.1582



Abdeckplatte für Scharniere

Material: Stahl vernickelt

200

Ausführung	Art. No.
Neutral	52.1572



Abdeckplatte für Scharniere

Material: Kunststoff schwarz

200

Ausführung	Art. No.
Neutral	52.1573



Glastürscharnier ohne Zuhaltung, für einliegende Türen von 4-6mm Stärke

Öffnungswinkel maximal 110°

Türgröße maximal: Höhe 1000 mm, Breite 500 mm

Material: Zamak

20

Installation links oben bzw. rechts unten

Oberfläche	Art. No.
Vernickelt poliert	52.1271

Zubehör: Führungsbuchse

Installation rechts oben bzw. links unten

Oberfläche	Art. No.
Vernickelt poliert	52.1270

Zubehör: Führungsbuchse

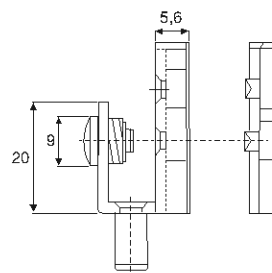
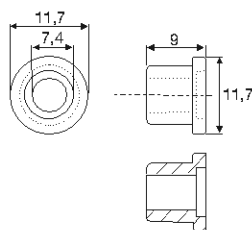
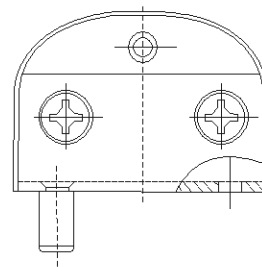
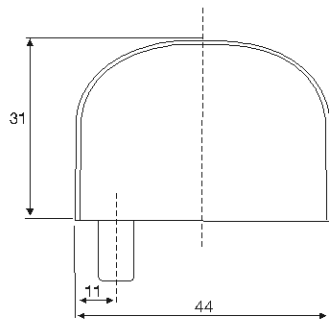



Keine Glasbohrung erforderlich

Glastürscharnier mit Zuhaltung, für einliegende Türen von 4-6mm Stärke

Öffnungswinkel maximal 105°

Scharnier arretiert in offener und geschlossener Stellung

Türgröße maximal: Höhe 1000 mm, Breite 500 mm

Material: Zamak

20

Installation links oben bzw. rechts unten

Oberfläche	Art. No.
Vernickelt poliert	52.1273

Installation rechts oben bzw. links unten

Oberfläche	Art. No.
Vernickelt poliert	52.1272

